

Bischoff & Bischoff

Instruction manual

Trinidad



Enjoy mobility.

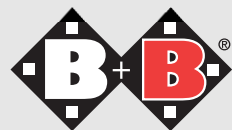

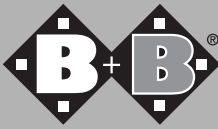

Trinidad shower stool (with back rest)

Dear customer,

with the purchase of this B+B shower stool you are now the owner of a high-quality German product that will make home care much easier. This instruction manual will familiarise you with the use and maintenance of your B + B shower stool and make your life safer.

We hope you enjoy your new product!

1. Declaration of Conformity

B+B as the manufacturer of the product declares that the Trinidad shower stool fully conforms to the requirements of Directive 93/42/EEC.

2. Information on using the product

The Trinidad shower stool is designed exclusively for use while showering.

3. Purpose - indications

Poor balance and inability to stand with reduced use of lower extremities (e.g. loss of strength with malignant diseases, chronic, advanced cardiovascular disease and lung diseases) combined with weakness in moving.

4. Caution - safety instructions - Risk analysis as per DIN EN ISO 13485

- An assistant is required for entering and leaving the seat
- Max. load capacity 120 kg
- Set all four feet to the same height.
- Make sure that the locking knobs are correctly seated
- When the seat is permanently fastened to the frame beware of the danger of becoming jammed.
- Seat is designed for sitting only

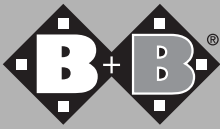

5. Assembly and installation

Insert side section into the seat frame and fasten from below with the sheetmetal screws (see Fig. 1 and 2).

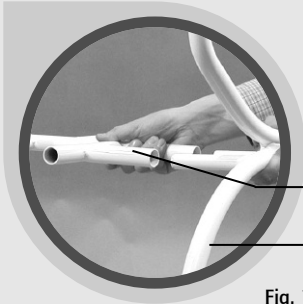

Fig. 1

Seat frame

Side frame

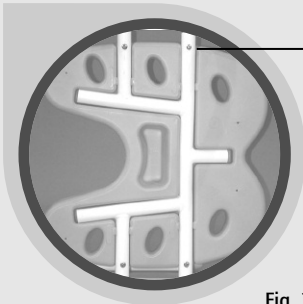

Fig. 2

Sheetmetal screw

The arms and the opening in the seat must be pointed forward for a correct seating position (see Fig. 3).



Fig. 3

The seat is locked to the seat frame by pressing it down forcefully (see Fig. 3).

To remove the seat hold it by the side of the frame and pull the seat from the frame.

6. Installing the seat back

The seat back is positioned on the side frame component (see Fig. 4) and fastened in the holes in the framework and seat back with fastening buttons (see Fig. 5)

7. Adjusting the height of the seat

The two feet are height-adjustable in five positions (adjustment range 10 cm).

Pull the lock out and set the leg to the desired position.

After setting the desired height insert the lock into the hole to lock the position (see Fig. 6 and 7).

All four feet must be set to the same height.

8. Cleaning and disinfecting the shower stool

Clean and disinfect the seat with standard cleaners and disinfectants only.

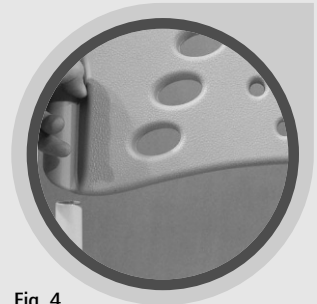

Fig. 4



Fig. 5



Fig. 6

Locking clamp

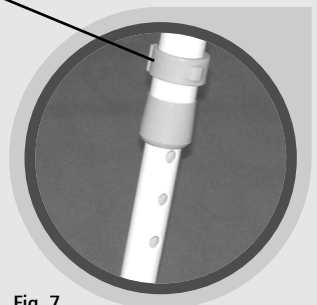
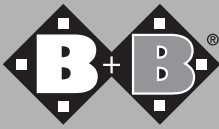

Fig. 7



9. Technical data

- Max. load capacity: 120 kg
- W/H/D (in mm): 510 / 580 / 800-900
- Weight: 4.7 kg.
- Seat height: 455-555 mm 5x by clip
- Seat width/depth: 400/400 mm
- Heat resistance: up to 125°C
- Colour: blue or white

10. Adjustment and repair tools

- 1 x Philips screwdriver
- 1 x Allen key no. 5

11. Marking of the product

A sticker is attached to the frame of the product with the product identification/serial number/max. user weight/company address.

12. Warranty

A warranty claim can only be accepted if the product is used under the specified conditions and for the specified purposes. The product must be returned in the original packaging.

13. Standard equipment

- 1/1 x side frame left/right
- 1 x seat frame
- 1 x B+B seat (plastic)
- 1 x B+B seat back (plastic)
- 4 x telescopic tubes
- 4 x locking pins
- 1 x screw set
- 2 x blind rivet (plastic white)

Warranty certificate

(Please note our general business terms and conditions)

Model: Trinidad shower stool

Serial number:*

(Please note our general business terms and conditions)

Dealer:

Date and stamp

* See the side frame for information stickers

Bischoff & Bischoff GmbH

Becker-Goering-Strasse 13 • D-76307 Karlsbad

Tel.: +49 700/6000 7070 • Fax: +49 700/6000 8080

www.bischoff-bischoff.com

info@bischoff-bischoff.de

